

YAMAHA AX-1090

Natural Sound Stereo Integrated Amplifier

Préampli/ampli de puissance stéréo de la série "Natural Sound"

Natural Sound Stereo-Verstärker

Natural Sound Integrerad Stereo Förstärkare

Amplificatore integrato stereo a Suono Naturale

Amplificador integrado estéreo de Sonido Natural

Natural Sound Geïntegreerde Stereo Versterker

**OWNER'S MANUAL
MODE D'EMPLOI
BEDIENUNGSANLEITUNG
BRUKSANVISNING
MANUALE DI ISTRUZIONI
MANUAL DE INSTRUCCIONES
GEBRUIKSAANWIJZING**

SUPPLIED ACCESSORIES
ACCESSOIRES FOURNIS
MITGELIEFERTES ZUBEHÖR
MEDFÖLJANDE TILLBEHÖR
ACCESSORI IN DOTAZIONE
ACCESORIOS INCLUIDOS
BIJGELEVERDE ACCESSOIRES

- After unpacking, check that the following parts are contained.
- Après le déballage, vérifier que les pièces suivantes sont incluses.
- Nach dem Auspacken überprüfen, ob die folgenden Teile vorhanden sind.
- Kontrollera efter det apparaten packats upp att följande delar finns med.
- Verificare che tutte le parti seguenti siano contenute nell'imballaggio dell'apparecchio.
- Desembale el aparato y verificar que los siguientes accesorios están en la caja.
- Controleer na het uitpakken of de volgende onderdelen voorhanden zijn.

- Remote Control Transmitter
- Emetteur de télécommande
- Fernbedienung
- Fjärrkontrollsändare
- Telecomando
- Transmisor del control remoto
- Afstandbediening

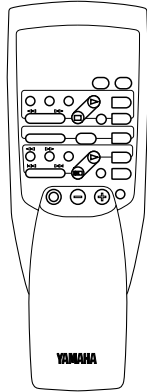

- Batteries (size AA, R6, UM-3)
- Piles (taille AA, R6, UM-3)
- Batterien (Größe AA, R6, UM-3)
- Batterier (storlek AA, R6, UM-3)
- Batterie (dimensioni AA, R6, UM-3)
- Pilas (tamaño AA, R6, UM-3)
- Batterijen (maat AA, R6, UM-3)

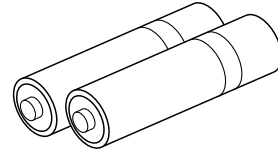

FEATURES

- **145W + 145W (8Ω) RMS Output Power, 0.01% THD, 20–20,000 Hz**
- **High Dynamic Power, Low Impedance Drive Capability**
- **Continuously Variable Loudness Control**
- **PURE DIRECT Switch to Reproduce the Purest Source Sound**
- **SUBSONIC FILTER Switch to Cut Out Undesirable Ultra-Low-Frequency Signals**
- **PRE OUT/MAIN IN Terminals for Connecting An Equalizer, Sound Processor, etc.**
- **Turnover Frequency Switch for Tone Controls**
- **High Quality Component Parts**
- **Remote Control Capability**

CONTENTS

Supplied Accessories	2
Connections	4
Controls and Their Functions	6
Operations	9
Notes about the Remote Control Transmitter	13
Troubleshooting	14
Specifications	15

CAUTION: READ THIS BEFORE OPERATING YOUR UNIT.

1. To assure the finest performance, please read this manual carefully. Keep it in a safe place for future reference.
2. Install this unit in a cool, dry, clean place – away from windows, heat sources, sources of excessive vibration, dust, moisture and cold. Avoid sources of humming (transformers, motors). To prevent fire or electrical shock, do not expose the unit to rain or water.
3. Never open the cabinet. If something drops into the set, contact your dealer.
4. Do not use force on switches, controls or connection wires. When moving the unit, first disconnect the power plug and the wires connected to other equipment. Never pull the wire itself.
5. The openings on the cabinet assure proper ventilation of the unit. If these openings are obstructed, the temperature inside the cabinet will rise rapidly. Therefore, avoid placing objects against these openings, and install the unit in well-ventilated condition. Make sure to allow a space of at least 20 cm behind, on the both sides and above the top panel of the unit. Otherwise it may not only damage the unit, but also cause fire.
6. Always set the VOLUME control to “– ∞” before starting the audio source play: increase the volume gradually to an appropriate level after the play has been started.
7. Do not attempt to clean the unit with chemical solvents; this might damage the finish. Use a clean, dry cloth.
8. Be sure to read the “TROUBLESHOOTING” section regarding common operating errors before concluding that the unit is faulty.
9. **When not planning to use this unit for long periods of time (ie., vacation, etc.), disconnect the AC power plug from the wall outlet.**
10. To prevent lightning damage, disconnect the AC power plug and disconnect the antenna cable when there is an electrical storm.
11. Grounding or polarization – Precautions should be taken so that the grounding or polarization of an appliance is not defeated.
12. AC outlet
Do not connect audio equipment to the AC outlet on the rear panel if that equipment requires more power than the outlet is rated to provide.

13. Voltage Selector (General Model only)

The voltage selector on the rear panel of this unit must be set for your local main voltage BEFORE plugging into the AC main supply.

Voltages are 110/120/220/240 V AC, 50/60 Hz.

IMPORTANT

Please record the serial number of this unit in the space below.

Serial No.:

The serial number is located on the rear of the unit. Retain this Owner's Manual in a safe place for future reference.

WARNING

TO REDUCE THE RISK OF FIRE OR ELECTRIC SHOCK, DO NOT EXPOSE THIS UNIT TO RAIN OR MOISTURE.

The apparatus is not disconnected from the AC power source as long as it is connected to the wall outlet, even if the apparatus itself is turned off.

CONNECTIONS

- Before attempting to make any connections to or from this unit, be sure to first switch OFF the power to this unit and to any other components to which connections are being made.
- When making connections between this unit and other components, be sure all connections are made correctly, that is to say **L** (left) to **L**, **R** (right) to **R**, “+” to “+” and “-” to “-”. Also, refer to the owner’s manual for each component to be connected to this unit.
- If you have YAMAHA components numbered as 1, 2, 3, etc. on the rear panel, connections can be made easily by making sure to connect the output (or input) terminals of each component to the same-numbered terminals of this unit.

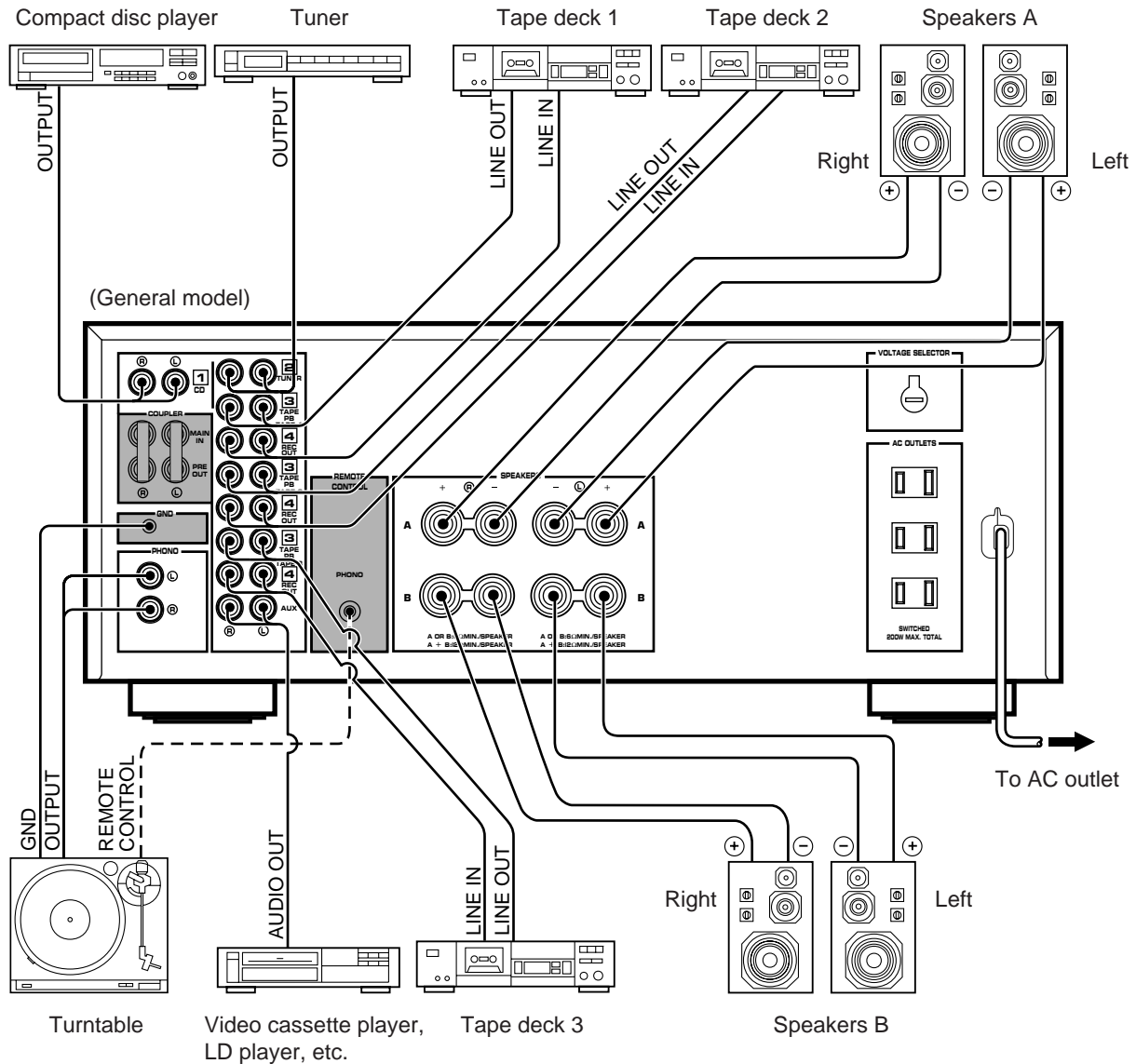

 : Refer to “**ABOUT THE OTHER REAR PANEL PARTS**” on page 5.

AC OUTLETS (3 SWITCHED OUTLETS)

Use these to connect the power cords from your components to this unit.

The power to the **SWITCHED** outlets is controlled by this unit’s **POWER** switch or the provided remote control transmitter’s **POWER** key. These outlets will supply power to any component whenever this unit is turned on.

The maximum power (total power consumption of components) that can be connected to the **SWITCHED AC OUTLETS** is 200 watts.

CONNECTING SPEAKERS

Connect the **SPEAKERS** terminals to your speakers with wire of the proper gauge, cut as short as possible. If the connections are faulty, no sound will be heard from the speakers. Make sure that the polarity of the speaker wires is correct, that is, + and – markings are observed. If these wires are reversed, the sound will be unnatural and will lack bass.

Do not let the bare speaker wires touch each other and do not let them touch the metal parts of this unit as this could damage this unit and/or speakers.

How to Connect:

Red: positive (+)
Black: negative (–)

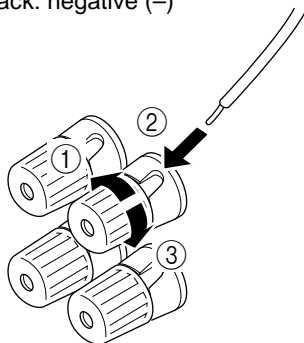

- ① Unscrew the knob.
- ② Insert the bare wire.
[Remove approx. 5mm (1/4") insulation from the speaker wires.]
- ③ Tighten the knob and secure the wire.

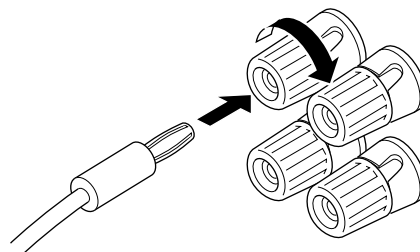

- One or two speaker systems can be connected to this unit. If you connect only one speaker system, connect it to either the **SPEAKERS A** or **B** terminals.
- Use speakers with the specified impedance shown on the rear of this unit.
- **<General model only>**
Banana Plug connections are also possible. Simply insert the Banana Plug connector into the corresponding terminal.

ABOUT THE OTHER REAR PANEL PARTS

REMOTE CONTROL (PHONO) connector

If you have a YAMAHA turntable with a terminal for remote control, connect it to this connector by using the cable provided with the turntable. This connection allows you to control the turntable from the provided remote control transmitter.

GND terminal (For turntable use)

Connecting the ground wire of the turntable to this terminal will normally minimize hum, but in some cases better results may be obtained with the ground wire disconnected.

PRE OUT/MAIN IN terminals

Removing the jumper pins enables this unit to independently perform the functions of a control amplifier and a power amplifier. These terminals are for connection of a signal-processing system such as a graphic equalizer or sound processor.

If a sound processor or other external unit is connected between these terminals, the **VOLUME** control of this unit can be used for overall adjustment of the level of sound.

To connect such a unit, remove the jumper pins from the **PRE OUT/MAIN IN** terminals, connect the inputs of that unit to the **PRE OUT** terminals and its outputs to the **MAIN IN** terminals. For details, refer to the owner's manual included with the unit to be connected.

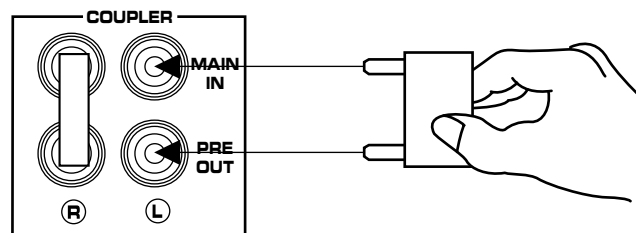

Notes

- If you will not use the **PRE OUT/MAIN IN** terminals, never remove the jumper pins from these terminals. If removed, no sound will be output from this unit.
- If you will use this unit with an external unit connected between the **PRE OUT** and **MAIN IN** terminals, make sure that the **PURE DIRECT** switch on the front panel is turned off.
- If you will use this unit as a power amplifier, connect the outputs of an external control amplifier etc. to this unit's **MAIN IN** terminals. In that case, this unit's controls will not function except the **PHONES** jack and the **SPEAKERS** switches, so use the controls on the external control amplifier to make volume adjustment etc.

CONTROLS AND THEIR FUNCTIONS

FRONT PANEL

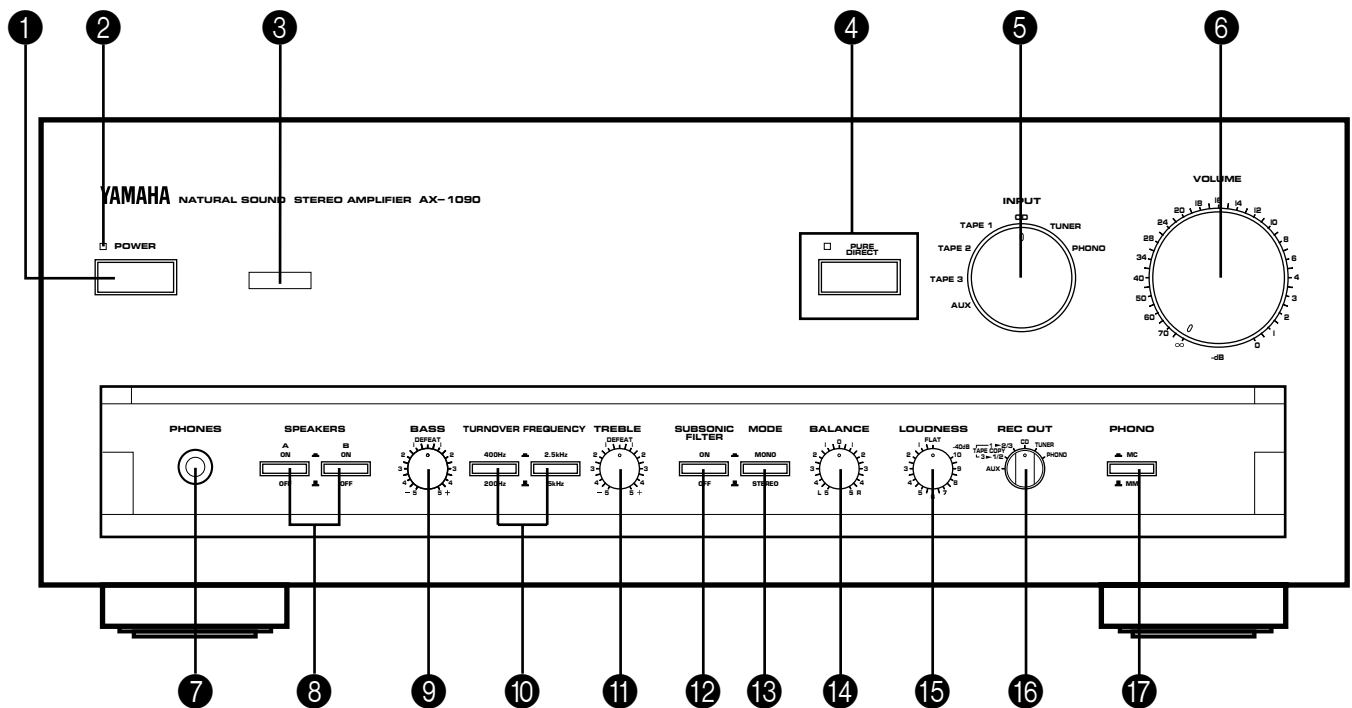

1 POWER switch

Press this switch to switch the power on. Press it again to switch the power off.

* Standby mode

While the power is on, pressing the **POWER** key on the remote control transmitter switches the unit to the standby mode. (In this mode, the power indicator is half illuminated.)

2 Power indicator

Lights up while the power is on.

3 Remote control sensor

Receives signals from the remote control transmitter.

4 PURE DIRECT switch and indicator

Press this switch so that the indicator lights up to listen to an audio source in the purest sound. (Refer to page 12 for details.)

5 INPUT selector

Selects a program source to listen to.

6 VOLUME control

Used to raise or lower the volume level.

* When the volume is decreased by pressing the **MUTING** key on the remote control transmitter, the indicator on the **VOLUME** control flashes on and off.

7 PHONES jack

When you listen with headphones, connect the headphones to the **PHONES** jack. When listening with headphones privately, set both the **SPEAKERS A** and **B** switches to the OFF position.

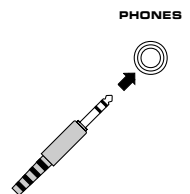

8 SPEAKERS switches

Set the switch **A** or **B** (or both **A** and **B**) for the speaker system (connected to this unit) you will use to the ON position. Set the switch for the speaker system you will not use to the OFF position.

9 BASS control

Used to increase or decrease the low frequency response. The DEFEAT position produces flat response.

10 TURNOVER FREQUENCY switches

Used to adjust the turnover point of the **BASS** and **TREBLE** controls respectively. This gives you flexible control over bass and treble response characteristics.

11 TREBLE control

Used to increase or decrease the high frequency response. The DEFEAT position produces flat response.

12 SUBSONIC FILTER switch

Used to cut out undesirable ultra-low-frequency signals caused by turntable rumble or warped records without losing sound quality.

13 MODE switch

This switch can be used for switching between stereo and monaural operation. Normally this switch should be set to the STEREO position.

14 BALANCE control

Adjusts the balance of the output volume to the left and right speakers to compensate for sound imbalance caused by speaker location or listening room conditions.

15 Continuously variable LOUDNESS control

Used to compensate for the human ears' loss of sensitivity to high and low-frequency ranges at low volume.

16 REC OUT selector

This switch can be used to select a program source and supply that source directly to the **REC OUT** terminals on the rear panel, independently of the setting of the **INPUT** selector. This function allows you to record the selected program source while listening to another program source.

17 PHONO (MM/MC) switch

This switch can be used to select either the MM (moving magnet) or MC (moving coil) position to match the phono cartridge used. (Refer to page 12 for details.)

REMOTE CONTROL TRANSMITTER

The remote control transmitter provided with this unit is designed to control all the most commonly used functions of this unit. If the CD player, tuner, tape deck and turntable connected to this unit are YAMAHA components designed for remote control compatibility, then this remote control transmitter will also control various functions of each component.

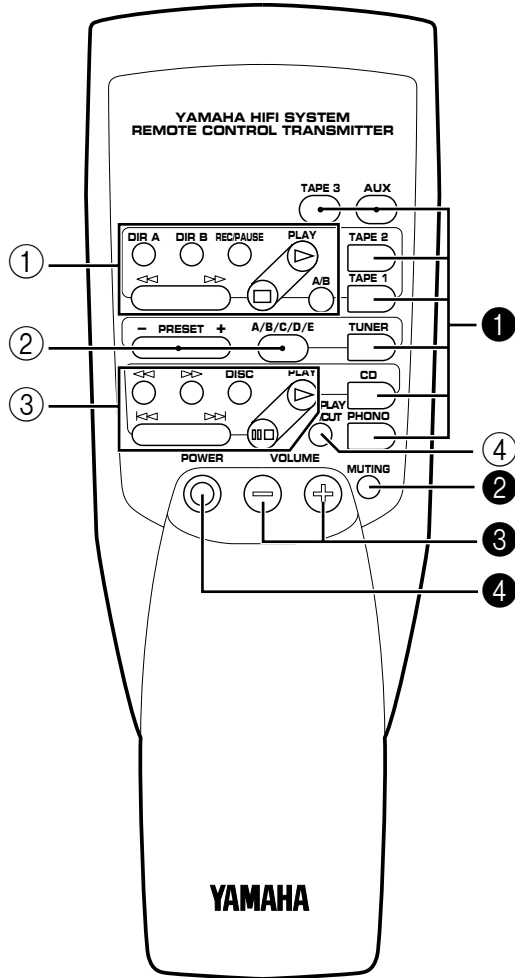

For Control of This Unit

① Input selector keys

Selects input source.

② MUTING key

When pressed, decreases the volume level by 20 dB. To resume original volume level, press this again.

While muting, the indicator on the **VOLUME** control flashes on and off continuously.

③ VOLUME +/- keys

Turns the volume level up/down.

④ POWER key

Turns the power on/off.

* While the power is on, pressing the **POWER** key on the remote control transmitter switches the unit from the power-on mode to the standby mode, and vice versa. (In the standby mode, the power indicator on the front panel is half illuminated.)

For Other Component Control

Identify the remote control transmitter keys with your component's keys. If these keys are identical, their functions will be the same. On each key function, refer to the corresponding instruction on your component's manual.

① Tape deck keys

Controls tape deck.

* **DIR A, B** and **A/B** are applicable only to double cassette tape deck.

* For a single cassette deck with automatic reverse function, pressing **DIR A** will reverse the direction of tape running.

② Tuner keys

Controls tuner.

+: Selects higher preset station number.

-: Selects lower preset station number.

A/B/C/D/E: Selects the group (A – E) of preset station numbers.

③ CD player keys

Controls compact disc player.

* **DISC** is applicable only to compact disc changer.

④ Turntable key

Starts/stops record play on turntable.

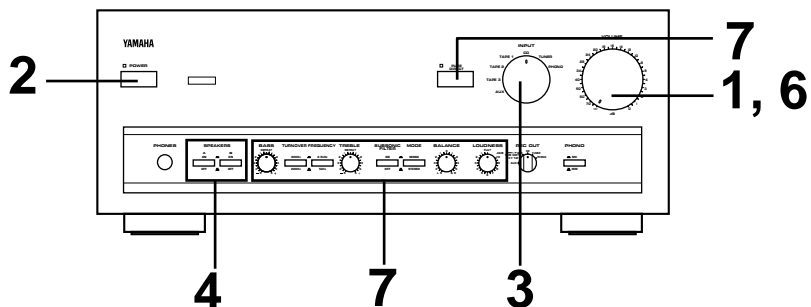

TO PLAY A SOURCE

1

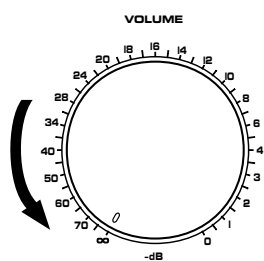

Set to the "∞" position.

2 Turn the power on.

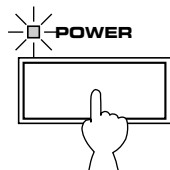

3 Select a desired input source.

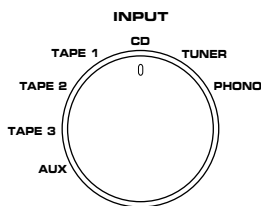

* If you select turntable as an input source (PHONO position), you should confirm that the **PHONO (MM/MC)** switch is set to the position corresponding to the type of cartridge being used by the turntable. (Refer to page 12.)

4 Select the speakers to be used.

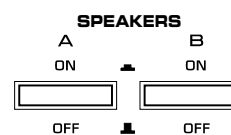

* If you use two speaker systems, press both the A and B switches.

5 Play the source.

6

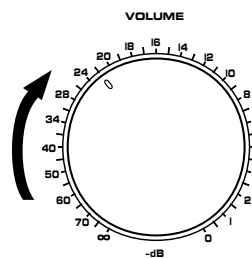

Adjust to the desired output level.

7 If desired, adjust the **BASS**, **TREBLE**, **BALANCE** and **LOUDNESS** controls, etc. (Refer to page 11–12.)

To turn off the power

Press the **POWER** switch again.

Caution

If you will press the **PURE DIRECT** switch to turn it on when the **LOUDNESS** control is set at a position other than "FLAT", be sure to decrease the volume by turning the **VOLUME** control counterclockwise before pressing the **PURE DIRECT** switch, otherwise the volume may become extremely high suddenly causing harm to your ears and damage to the speakers.

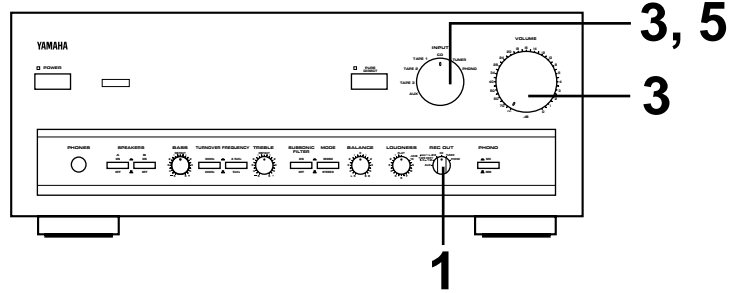

TO RECORD A SOURCE TO TAPE (OR DUB FROM A TAPE TO ANOTHER)

- 1** Select the source to be recorded.

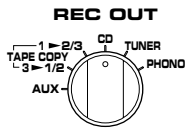

- 2** Play the source.

- 3** Confirm the source by selecting it with the **INPUT** selector and turning up the **VOLUME** control.

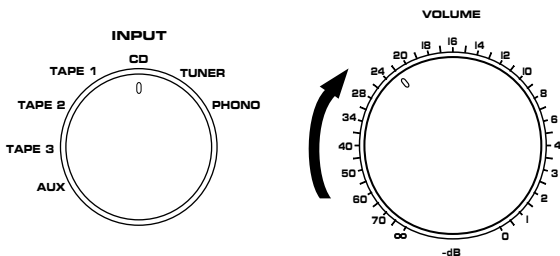

- 4** Set the tape deck to be used for recording in the recording mode.

- 5** To monitor the sound to be recorded (or being recorded), select the tape deck being used for recording with the **INPUT** selector.

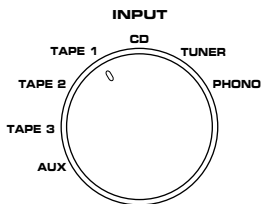

Notes

- If you want to enjoy another source while recording, select it with the **INPUT** selector.
- The settings of **VOLUME**, **BASS**, **TREBLE**, **BALANCE**, **LOUDNESS** controls and **PURE DIRECT** switch have no effect on the material being recorded.

REC OUT selector setting on tape dubbing

To dub from tape deck 1 to tape deck 2 or 3 (or both tape deck 2 and 3 at the same time)

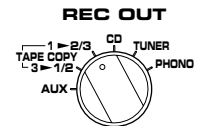

To dub from tape deck 3 to tape deck 1 or 2 (or both tape deck 1 and 2 at the same time)

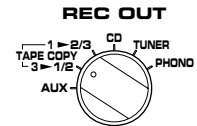

* Tape dubbing cannot be done from tape deck 2 to tape deck 1 or 3.

Adjusting the BALANCE control

Adjust the balance of the output volume to the left and right speakers to compensate for sound imbalance caused from speaker location or listening room conditions.



Selecting the SPEAKER system

Because one or two speaker systems can be connected to this unit, the **SPEAKERS** switches allow you to select speaker system **A** or **B**, or both at once.

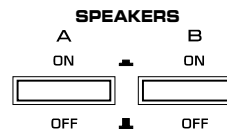

Adjusting the BASS and TREBLE controls



BASS : Turn this clockwise to increase (or counter-clockwise to decrease) the low frequency response.

TREBLE : Turn this clockwise to increase (or counter-clockwise to decrease) the high frequency response.

Adjusting the continuously variable LOUDNESS control

This control provides compensation for the human ears' loss of sensitivity to high and low-frequency ranges at low volume. This control is adjustable to retain full tonal range at any volume level.

1 Set to the "FLAT" position.

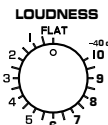

2 Set to the loudest listening level that you would listen to.

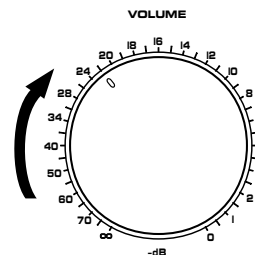

3 Turn until the desired volume is achieved.

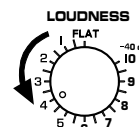

TURNOVER FREQUENCY switches

These switches can be used to adjust the turnover point of the tone controls: either 200 Hz or 400 Hz for **BASS** and either 2.5 kHz or 5 kHz for **TREBLE**. This gives you flexible control over bass and treble response characteristics.

TURNOVER FREQUENCY

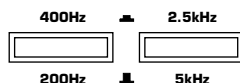

Using the PURE DIRECT switch

You can enjoy the purest possible sound from your audio sources by setting this switch so that the indicator lights up. By doing so, the audio signals bypass the **BASS**, **TREBLE**, **BALANCE**, **LOUDNESS** controls, **SUBSONIC FILTER** switch, **MODE** switch and the **PRE OUT/MAIN IN** terminals, thus eliminating any alterations to the audio signals.

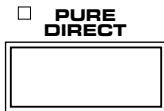

PHONO (MM/MC) switch

Select either MM or MC position depending on your PHONO cartridge, Moving Magnet or Moving Coil type. However, if you use a high output MC cartridge, select MM position. To select the MC position, press this switch so that it is held inward. To select the MM position, press this switch so that it is released outward.

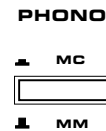

Setting the SUBSONIC FILTER switch

If you set this switch to "ON" position, undesirable ultra-low-frequency signals caused by turntable rumble or warped records can be cut out without losing sound quality.

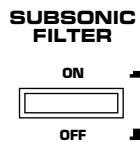

Setting the MODE switch

This switch can be used for switching between stereo and monaural operation. Normally this switch should be set to the STEREO position.

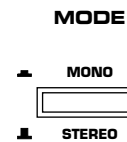

Open/close the control door

When it is not necessary to operate controls inside the control door, close the door.

To open the door

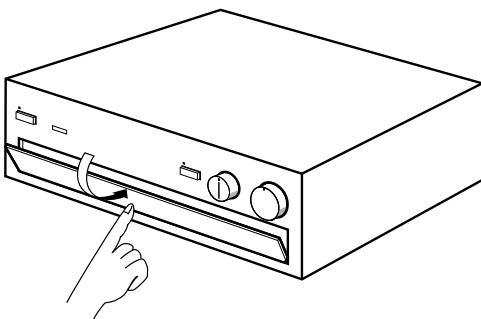

To close the door

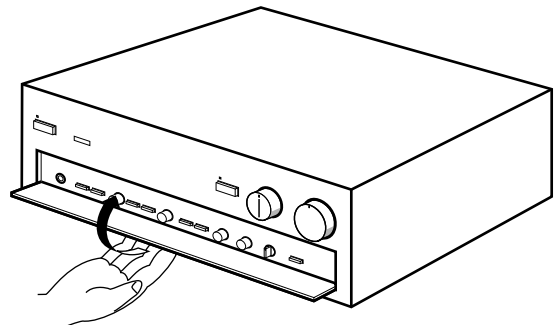

NOTES ABOUT THE REMOTE CONTROL TRANSMITTER

Battery installation

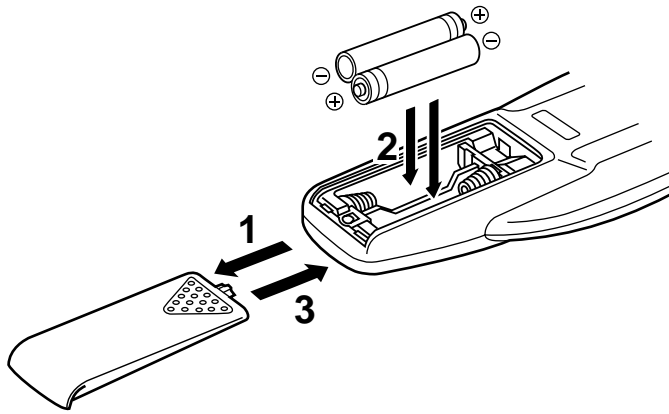

Remote control transmitter operation range

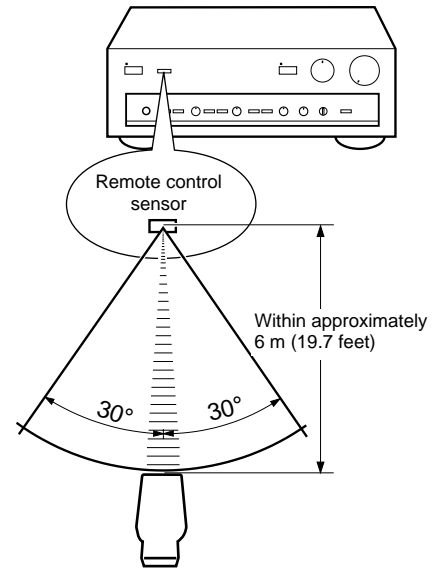

Battery replacement

If you find that the remote control transmitter must be used closer to the main unit, the batteries are weak. Replace both batteries with new ones.

Notes

- Use only AA, R6, UM-3 batteries for replacement.
- Be sure the polarities are correct. (See the illustration inside the battery compartment.)
- Remove the batteries if the remote control transmitter will not be used for an extended period of time.
- If batteries leak, dispose of them immediately. Avoid touching the leaked material or letting it come in contact with clothing, etc. Clean the battery compartment thoroughly before installing new batteries.

Notes

- There should be no large obstacles between the remote control transmitter and the main unit.
- If the remote control sensor is directly illuminated by strong lighting (especially an inverter type of fluorescent lamp etc.), it might cause the remote control transmitter not to work correctly. In this case, reposition the main unit to avoid direct lighting.

TROUBLESHOOTING

If the unit fails to operate normally, check the following points to determine whether the fault can be corrected by the simple measures suggested. If it cannot be corrected, or if the fault is not listed in the SYMPTOM column, disconnect the power cord and contact your authorized YAMAHA dealer or service center for help.

SYMPTOM	CAUSE	REMEDY
The unit fails to turn on when the POWER switch is pressed.	Power cord is not plugged in or is not completely inserted.	Firmly plug in the power cord.
No sound.	Incorrect output cord connections.	Connect the cords properly. If the problem persists, the cords may be defective.
	Appropriate input source is not selected.	Select an appropriate input source with the INPUT selector.
	The SPEAKERS switches are not set properly.	Set the SPEAKERS switch which corresponds to the speakers to be used to the ON position.
	Speaker connections are not secure.	Secure the connections.
The sound suddenly goes off.	The protection circuit has functioned because of short circuit etc.	Turning the unit off and then on will reset the protection circuit.
Only one side speaker outputs the sound.	Incorrect setting of the BALANCE control.	Adjust it to the appropriate position.
	Incorrect cord connections.	Connect the cords properly. If the problem persists, the cords may be defective.
There is a lack of bass, and no ambience.	The + and – wires are connected in reverse at the amplifier or speakers.	Connect the speaker wires in the correct phase (+ and –).
Sound “hums”.	Incorrect cord connections.	Firmly connect the audio plugs. If the problem persists, the cords may be defective.
	No connection from the turntable to the GND terminal.	Make the GND connection between the turntable and this unit.
Sound level is low or sound is distorted while playing a record on the turntable.	The LOUDNESS control is functioning.	Set the LOUDNESS control to the FLAT position.
	The PHONO (MM/MC) switch is set to the improper position.	Set the PHONO (MM/MC) switch to the proper position.
	The MUTING key is ON.	First, turn the volume control to the full left. Then, turn the MUTING key OFF with the remote control transmitter and adjust the volume.
Using the BASS, TREBLE, BALANCE, LOUDNESS controls, SUBSONIC FILTER switch and MODE switch does not affect the tone.	The PURE DIRECT switch is ON.	The PURE DIRECT switch must be switched OFF to use those controls.
The volume level cannot be increased, or sound is distorted.	The power to the component connected to the REC OUT terminals of this unit is off.	Turn the power to the component on.
The sound is degraded when listening with the headphones connected to the compact disc player or cassette deck that are connected with this unit.	The power to this unit is off.	Turn the power to this unit on.
The remote control transmitter does not work.	Direct sunlight or lighting (of an inverter type of fluorescent lamp etc.) is striking the remote control sensor of the main unit.	Change position of the main unit.
The distance or range within which the remote control transmitter can be used decreases.	The batteries of this remote control transmitter are too weak.	Replace the batteries with new ones.

SPECIFICATIONS

Minimum RMS Output Power per Channel 8 ohms, 20 Hz to 20 kHz, 0.01% THD145W+145W 6 ohms, 20 Hz to 20 kHz, 0.02% THD185W+185W	Headphone Jack Rated Output/ Impedance Output Level (8 ohms, 1 kHz, 0.015% THD)1.05V Impedance220 ohms	Tone Control Characteristics BASS: Boost/cut±10 dB (20 Hz) Turnover Frequency200, 400 Hz TREBLE: Boost/cut±10 dB (20 kHz) Turnover Frequency2.5, 5 kHz
Dynamic Power per Channel (by IHF Dynamic Headroom measuring method) 8/6/4/2 ohms220/290/360/460W	Frequency Response (20 Hz to 20 kHz) CD/TUNER/TAPE/AUX0±0.5 dB MAIN IN0±0.5 dB	Filter Characteristics SUBSONIC FILTER15 Hz, -18 dB/oct
DIN Standard Output Power per Channel [Europe model only] (4 ohms, 1 kHz, 0.7% THD)250W	RIAA Equalization Deviation (20 Hz to 20 kHz) PHONO MM±0.3 dB PHONO MC±0.5 dB	Continuous Loudness Control (Level related equalization) Attenuation-40 dB (1 kHz)
Dynamic Headroom [General model only] 8/6 ohms1.81 dB/1.95 dB	Total Harmonic Distortion (20 Hz to 20 kHz) PHONO MM to REC OUT (3V)0.003% PHONO MC to REC OUT (3V)0.007% CD/TUNER/TAPE/AUX to PRE OUT (1V)0.004% CD/TUNER/TAPE/AUX to SP OUT (72.5W/8 ohms)0.007% MAIN IN to SP OUT (72.5W/8 ohms)0.005%	Audio Muting-20 dB Gain Tracking Error (0 to -60 dB)2 dB
IEC Power (8 ohms, 1 kHz, 0.01% THD) [Europe model only]170W		Power Supply [Europe model]AC 230V, 50 Hz [General model]AC 110/120/220/240V, 50/60 Hz
Power Band Width 8 ohms, 72.5W, 0.03% THD10 Hz to 50 kHz		Power Consumption370W
Damping Factor 8 ohms, 20 Hz to 20 kHz350 or more	Signal-to-Noise Ratio (IHF-A Network) PHONO MM (5 mV Input Shorted)92 dB PHONO MC (500 µV Input Shorted)75 dB CD (Input Shorted) (PURE DIRECT; ON)110 dB TUNER/TAPE/AUX (Input Shorted) (PURE DIRECT; ON)106 dB	AC Outlets 3 SWITCHED OUTLETS200W max. total
Input Sensitivity/Impedance PHONO MM2.5 mV/47 k-ohms PHONO MC160 µV/220 ohms CD/TUNER/TAPE/AUX150 mV/47 k-ohms MAIN IN1.0V/47 k-ohms		Dimensions (W x H x D)435 x 171 x 448 mm (17-1/8" x 6-3/4" x 17-5/8")
Maximum Input Signal (1 kHz, 0.01% THD) PHONO MM170 mV PHONO MC13.5 mV	Residual Noise (IHF-A Network) CD (PURE DIRECT; ON)40 µV TUNER/TAPE/AUX (PURE DIRECT; ON)80 µV	Weight18.3 kg (40 lbs. 4 oz.)
Output Level/Impedance REC OUT150 mV/2.2 k-ohms PRE OUT1.0V/1.8 k-ohms	Channel Separation (Vol. -30 dB) PHONO MM/MC (Input Shorted) 1 kHz/10 kHz)70 dB/55 dB CD/TUNER/TAPE/AUX (Input 5.1 k-ohms Terminated 1 kHz/10 kHz)65 dB/50 dB	Accessories...Remote control transmitter Batteries
Maximum Voltage Output 20 Hz to 20 kHz, 0.02% THD6.5V		Specifications subject to change without notice.

YAMAHA

YAMAHA ELECTRONICS CORPORATION, USA 6660 ORANGETHORPE AVE., BUENA PARK, CALIF. 90620, U.S.A.
YAMAHA CANADA MUSIC LTD. 135 MILNER AVE., SCARBOROUGH, ONTARIO M1S 3R1, CANADA
YAMAHA ELECTRONIK EUROPA G.m.b.H. SIEMENSSTR. 22-34, 25462 RELLINGEN BEI HAMBURG, F.R. OF GERMANY
YAMAHA ELECTRONIQUE FRANCE S.A. RUE AMBROISE CROIZAT BP70 CROISSY-BEAUBOURG 77312 MARNE-LA-VALLEE CEDEX02, FRANCE
YAMAHA ELECTRONICS (UK) LTD. YAMAHA HOUSE, 200 RICKMANSWORTH ROAD WATFORD, HERTS WD1 7JS, ENGLAND
YAMAHA SCANDINAVIA A.B. J A WETTERGRENS GATA 1, BOX 30053, 400 43 VÄSTRA FRÖLUNDA, SWEDEN
YAMAHA MUSIC AUSTRALIA PTY, LTD. 17-33 MARKET ST., SOUTH MELBOURNE, 3205 VIC., AUSTRALIA

YAMAHA CORPORATION

VU 60520